

Control Modes

- Velocity, Torque

Command Interface

- ±10V velocity/torque command
- PWM velocity/torque command

Communications

- RS232

Feedback

- Back-EMF (velocity mode)

I/O - Digital

- 5 inputs, 1 output

Dimensions: mm [in]

- 130 x 82 x 31 [5.1 x 3.2 x 1.2]



MODEL	I _c	I _p	V _{dc}
JSP-090-10	5	10	90
JSP-090-20	10	20	90
JSP-180-10	5	10	180
JSP-180-20	10	20	180
JSP-180-30	15	30	180

DESCRIPTION

The *Junus*[™] digital servoamplifier puts 100% digital control of DC brush motors in a panel-mounting package with power options to ±15 Adc continuous and ±30 Adc peak from +20 Vdc to +180 Vdc DC power supplies.

Torque mode operation works with popular position-loop controllers that use PID filters to close a position-loop. Sensorless velocity control works with position loop controllers that only output a position-error signal such as PLC's.

Set-up is fast and automated by *CME 2*[™] software operating under Windows®.

CME 2[™] communicates with *Junus*[™] through an RS-232 link for complete amplifier setup. Auto-tuning algorithms in *CME 2*[™] slash set up times for fast system commissioning by automating current and velocity-loop tuning. A powerful oscilloscope and signal generator display amplifier performance for fine tuning thereafter.

Amplifier control parameters are saved in non-volatile flash memory. OEM's can inventory one part, and configure amplifiers on-site to each axis in a machine.

Current-loop sampling at 20 kHz yields high-bandwidth with full adjustability. The velocity loop is sampled at 4 kHz for wide velocity bandwidths.

Carrier-cancellation modulation all but eliminates motor ripple current and dissipation at a standstill, and provides excellent crossover characteristics for voice-coil applications that demand low distortion around zero. PWM ripple is at 40 kHz, further minimizing losses in low-inductance motors.

Sensorless velocity control regulates motor back-EMF and compensates for changes in load that would cause a speed change with simple voltage controls. Amplifier output voltage is increased to offset the internal I*R voltage drops, keeping back-emf constant. All amplifier circuits are DC coupled and operate from unregulated transformer-isolated DC power supplies, or regulated switching power supplies.

The panel-mount package is compatible with the mounting footprint of Copley's 4xx series analog DC brush-motor amplifiers, offering an easy upgrade to 100% digital control.

GENERAL SPECIFICATIONS

 Test conditions: Load = 1mH in series with 1 Ω. Ambient temperature = 25 °C. +HV = HV_{max}

MODEL	JSP-090-10	JSP-090-20	JSP-180-10	JSP-180-20	JSP-180-30	
OUTPUT POWER						
Peak Current	10	20	10	20	30	Adc
Peak time	1	1	1	1	1	s
Continuous current	5	10	5	10	15	Adc
Peak Output Power	0.85	1.64	1.73	3.41	5.12	kW
Continuous Output Power	0.43	0.85	0.87	1.73	2.56	kW
INPUT POWER						
HV _{min} to HV _{max}	+20 to +90	+20 to +90	+20 to +180	+20 to +180	+20 to +180	Vdc, transformer-isolated
Peak current	10	20	10	20	30	Adc (1 sec)
Continuous current	4.53	9.07	4.53	9.07	13.6	Adc
PWM OUTPUTS						
Type	MOSFET H-bridge , 20 kHz center-weighted PWM carrier					
PWM ripple frequency	40 kHz					
BANDWIDTH						
Current loop, small signal	3 kHz typical, bandwidth will vary with tuning & load inductance					
HV Compensation	HV _{min} to HV _{max} , changes in HV do not affect bandwidth					
Current loop update rate (period)	20 kHz (50 μs)					
Velocity loop update rate (period)	4 kHz (250 μs)					
REFERENCE INPUTS						
Analog torque & velocity reference	±10 Vdc, 12 bit resolution			Differential		
Input impedance	66 kΩ			Between Ref(+), Ref(-)		
Digital torque & velocity reference (Note 1)	PWM [IN5], Polarity [IN4]			PWM = 0% to 100%, Polarity = 1/0 or PWM = 50% ±50%, no polarity signal required		
	PWM frequency range			1 kHz minimum, 100 kHz maximum		
	PWM minimum pulse width			220 ns		
DIGITAL INPUTS (NOTE 1)						
All inputs	74HCT14 Schmitt trigger operating from +5.0 Vdc with RC filter on input					
RC filters	RC filter time-constants assume active drive on inputs and do not include 10 kΩ pull-up (pull-down)					
Pull-up/pull-down	GP inputs: 330 μs, HS inputs: 100 ns					
Logic levels	Group-programmable: [IN1,2,3] have pull-ups to +5 Vdc or pull-downs to signal ground					
Input Polarity	Non-programmable: [IN4] and [IN5] have pull-ups to +5 Vdc					
Amp Enable [IN1]	Vin-LO < 0.5 V, Vin-HI > 1.9 V, Maximum input voltage = +10 VDC					
GP [IN2,3]	Active level is programmable via CME 2™ software					
HS [IN4,5]	1 GP input dedicated to amplifier enable function, active level and reset functions programmable					
	2 GP inputs with programmable functions and active level select					
	2 HS Inputs inputs programmable functions, and active level select					
SERIAL DATA INPUT						
RS-232	RxD, TxD, Gnd in 6-position, 4-contact RJ-11 type modular connector, and on J2					
	Full-duplex, serial communication port for amplifier setup and control, 9600 to 115200 baud					
	Protocol: binary					
MOTOR CONNECTIONS						
Mot(+), Mot(-)	Amplifier outputs to DC brush motor or voice-coil motor with ungrounded winding					
STATUS INDICATOR						
Amp Status	Bicolor LED. Amplifier status indicated by color and blinking or non-blinking condition					
DIGITAL OUTPUT (NOTE 1)						
Type	Current-sinking MOSFET open-drain output with 1 kΩ pullup to +5 Vdc through diode, 1 Adc sink max, 40Vdc max.					
Functions	Programmable					
Active Level	Programmable to either HI (off, pull-up to +5 Vdc) or LO (on, current-sinking) when output is active					
PROTECTIONS						
HV Overvoltage	+HV > HV _{max}	Amplifier outputs turn off until +HV < HV _{max} (See Input Power for HV _{max})				
HV Undervoltage	+HV < +20 Vdc	Amplifier outputs turn off until +HV > +20 Vdc				
Amplifier over temperature	PC Board > 70 °C	Amplifier latches OFF until Enable input (Note 1) cycled, power off-on, or Reset				
Short circuits		Output to output, output to ground, internal PWM bridge faults				
I ² T Current limiting		Programmable: continuous current, peak current, peak time				
MECHANICAL & ENVIRONMENTAL						
Size	5.10 in (129,5 mm) X 3.22 in (81,79 mm) X 1.17 in (29,72 mm)					
Weight	0.66 lb (0.30 kg) for amplifier without heatsink					
Ambient temperature	0 to +45 °C operating, -40 to +85 °C storage					
Humidity	0% to 95%, non-condensing					
Contaminants	Pollution degree 2					
Environment	IEC68-2: 1990					
Cooling	Heat sink and/or forced air cooling may be required for continuous power output (see pp. 8 & 9)					

NOTES

1. Functions of [IN2,3,4,5] and [OUT1] are programmable

AGENCY STANDARDS CONFORMANCE

EN 55011 : 1998	CISPR 11 (1997) Edition 2/Amendment 2: Limits and Methods of Measurement of Radio Disturbance Characteristics of Industrial, Scientific, and Medical (ISM) Radio Frequency Equipment
EN 50082-1 : 1997	Electromagnetic Compatibility Generic Immunity Requirements
<i>Following the provisions of EC Directive 89/336/EEC:</i>	
EN 60204-1 : 1997	Safety of Machinery - Electrical Equipment of Machines
<i>Following the provisions of EC Directive 98/37/EC:</i>	
UL 508C : 1996	UL Standard for Safety for Power Conversion Equipment

COMMUNICATION

Junus™ is configured via a three-wire, full-duplex RS-232 port that operates from 9600 to 115,200 Baud. CME 2™ provides a GUI (graphic user interface) to set up all of Junus™ features via a computer serial port. Connections to the RS-232 port J3 are via an RJ-11 style connector, or through the signal connector J2 (J2-8, 15 & 7). Rx/D, and Tx/D signals are supported. The Serial Cable Kit contains a modular cable, and an adapter that connects to a 9-pin, Sub-D serial port connector (COM1, COM2, etc.) on PC's and compatibles.

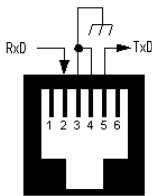

STATUS LED

A single bi-color LED gives the state of the amplifier by changing color and by blinking or remaining on. The possible color and blink combinations are:

- **Green/Solid:** Amplifier OK and enabled. Will run in response to reference input signals.
- **Green/Slow-Blinking:** Amplifier OK but not-enabled. Will run when enabled.
- **Green/Fast-Blinking:** Positive or Negative limit switch is active. Amplifier will only move in direction not inhibited by limit switch.
- **Red/Solid:** Temporary fault condition. Amplifier will resume operation when fault is removed.
- **Red/Blinking:** Latching fault. Operation will not resume until amp is Reset or powered off-on.

Faults are programmable as latching or non-latching. Latching fault conditions stay in effect until the amplifier is reset, or powered off-on.

DIGITAL INPUTS

There are five digital inputs. Inputs [IN1], [IN2], and [IN3] have 10 kΩ resistors that are group-programmable to pull-up to +5 Vdc or pull-down to signal ground. The resistors on [IN5] and [IN4] pull-up to +5 Vdc. Input RC filters are of two types: GP (general-purpose) and HS (high-speed). [IN1] is a GP input that always functions as the Enable input and controls the ON/OFF state of the amplifier outputs. The other four digital inputs, [IN2], [IN3], [IN4], and [IN5] have alternate functions that are settable via CME 2™:

- Positive Limit Switch
- Negative Limit Switch
- Amplifier Reset
- Motor Temp Sensor
- Digital Reference Input [IN4,5]

In addition to the alternate functions, the active level for each input is individually programmable.

Amplifier reset takes place on transitions of the input and is programmable to 1/0 or 0/1. The motor temp sensor function will disable the amplifier if a switch in the motor opens or closes when the motor overheats. If the inputs are set to pull-up to +5 Vdc, the other terminal of the motor switch should be grounded. If the inputs are set to pull-down to ground, the motor temp switch should then be connected to +5 Vdc. The active-level setting is then set depending on the type of switch: normally open, or normally closed.

[IN1] can function simply as the amp-enable or as the amp-enable with reset. With the reset options selected, the amplifier will reset when [IN1] goes from the active to the inactive level. The default selection is active-LO with no reset. When this default is combined with the input resistor pull-up to +5 Vdc, the amplifier is in a fail-safe condition. In order to make the amplifier operate, the enable input must be connected and must be grounded to operate the amplifier. If a wire were to break, or the controller malfunction, the input would not be grounded and

the amplifier would not operate. The active-LO with pull-up to +5 Vdc and active-HI with pull-downs to ground are both fail-safe combinations. Active-HI with pull-up to +5 Vdc and active-LO with pull-downs to ground are not fail-safe. These combinations are not typically used because they permit the amplifier to operate even if there is no connection to the enable input.

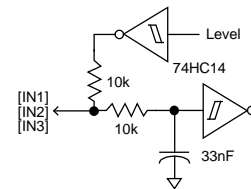

GP inputs with programmable pull-up/pull-down resistors (see Digital Reference Inputs on p. 4 for [IN4,5])

DIGITAL OUTPUT

The digital output [OUT1] is an open-drain MOSFET with a 1 kΩ pull-up resistor to +5 Vdc. This can sink up to 1 A from external loads operating from power supplies to +30 Vdc.

The output can function as either an amplifier status (Normal, Fault) or motor brake driver.

As an amplifier status output, the active level is programmable to be HI or LO when the amplifier is enabled and operating normally. As a brake output, it is programmable to be either HI or LO to release a motor brake when the amplifier is enabled.

When driving inductive loads such as a relay, an external fly-back diode is required. A diode in the output is for driving PLC inputs that are opto-isolated and connected to +24 Vdc. The diode prevents conduction from +24 Vdc through the 1 kΩ resistor to +5 Vdc in the amplifier. This could turn the PLC input on, giving a false indication of the amplifier output state.

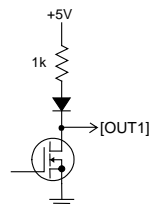

REFERENCE INPUTS

The Reference inputs command the amplifier to produce an output. *Junus*™ has analog and digital reference inputs. Only one can be active at a time.

The analog input takes a ±10 Vdc signal, and the digital input(s) take either two, or one digital signals to command motor current or velocity.

ANALOG REFERENCE INPUT

The analog ±10 Vdc signal is an industry standard for torque or velocity control. The analog reference input is a differential amplifier which is to be connected to the motion controller ground and DAC output. Using a differential amplifier is important because there may be potential differences between the amplifier and controller grounds. A differential amplifier rejects these differences and measures the controller output referenced to ground at the controller.

The voltage *between* Ref(+) and Ref(-) inputs must be zero to produce a “zero” amplifier output. Because the reference amplifier is connected to +1.5 Vdc internally, grounding Ref(-), and allowing Ref(+) to be open will produce a large command, as will grounding Ref(+) and letting Ref(-) be open. *When wiring the controller DAC output to the reference inputs, be sure to use both reference inputs, and connect Ref(-) to ground at the controller, and not at the amplifier.*

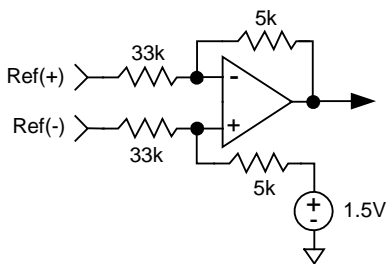

IMPORTANT!

ALWAYS CONNECT BOTH ANALOG REF INPUTS.

THERE MUST BE ZERO VOLTS BETWEEN REF(+) & REF(-) FOR ZERO OUTPUT FROM THE AMPLIFIER!

DIGITAL REFERENCE INPUTS

[IN4] and [IN5] are logic inputs for digital reference signals that are programmable for controlling torque or velocity. If they are not used as reference inputs they can be programmed with the same functions as [IN2] & [IN3]. The electrical structure of these inputs is shown below:

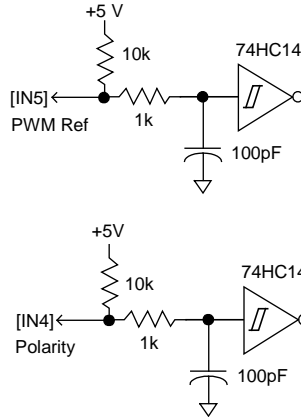

For torque or velocity control, the inputs may be configured in two formats:

1. PWM (0~100%) & Polarity
2. PWM (50%)

In the first case, the PWM signal on [IN5] can vary from 0% to 100%, and the Polarity signal on [IN4] is a DC level that controls the direction of the motor. The PWM duty-cycle controls the amplifier output current, or motor velocity. In current mode, 100% corresponds to the maximum output current. In velocity mode, it commands the maximum velocity that is configured.

[IN4] & [IN5] have pull-up resistors to +5 Vdc so that they can be controlled by an open-collector, TTL, or CMOS drivers.

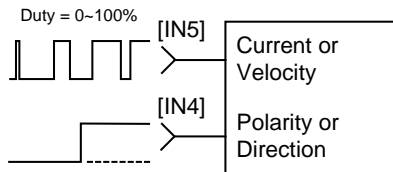

Another type of PWM input is the “50%” type. There is only one PWM signal that connects to [IN5]. The other digital input, [IN4], is not used in this mode. A 50% duty-cycle corresponds to a zero-current command in torque mode, or a zero-speed command in velocity mode.

Duty-cycles of 0%, and 100% would result in negative full-scale or positive full-scale outputs. The duty-cycle controls not only the magnitude, but also the polarity of the amplifier output.

The scale-factor for amplifier-output vs. PWM input is settable via *CME 2*™ software in both cases.

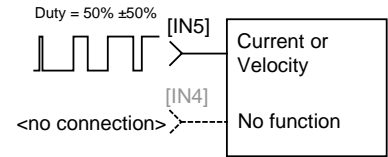

MOTOR CONNECTIONS

Motor connections are the positive and negative terminals of a DC brush motor, or voice-coil motor. The connections carry the amplifier output currents that drive produce torque, or force in the case of a voice-coil.

The amplifier output is an H-bridge PWM stage that converts the DC buss voltage (+HV) into voltage waveforms that drive the motor winding. The output currents from the (+) and (-) outputs are balanced, so individual conductors in the motor cable should be sized for the continuous current rating of the amplifier. Motor cabling should use twisted, shielded conductors for CE compliance, and to minimize PWM noise coupling into other circuits. The motor cable shield should connect to motor frame and an amplifier HV ground terminal (J1-3) for best results.

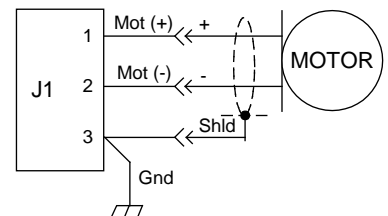

GROUNDING CONSIDERATIONS

All of the circuits in Junus™ share a common circuit-ground (Ground on J1-3, 4 and Signal Ground on J2-7,10,11,12, and J3-3 & 4). Input logic circuits are referenced to Signal Ground, as are analog reference inputs, and the digital output. For this reason, amplifier Gnd terminals should connect to the users' common ground system so that signals between amplifier and controller are at the same common potential, and to minimize noise. The system ground should, in turn, connect to an earthing conductor at some point so that the whole system is referenced to "earth".

Because current flow through conductors produces voltage-drops across them, it is best to connect the amplifier HV Gnd to system earth, or circuit-common through the shortest path, and to leave the power-supply floating. In this way, the power supply (-) terminal connects to ground at the amplifier HV Gnd terminals, and the voltage drops across the cables will not appear at the amplifier ground, but at the power supply negative terminal where they will have less effect.

Motor phase currents are balanced, but currents can flow between the PWM outputs, and the motor cable shield. To minimize the effects of these currents on nearby circuits, the cable shield should connect to Gnd (J1-3).

The amplifier case does not connect to any amplifier circuits. Connection to the case are provided on connector J2-1. Cables to this connector should be shielded for CE compliance, and the shield should connect to this terminal. When installed, the amplifier case should connect to the system chassis. This maximizes the shielding effect of the case, and provides a path to ground for noise currents that may occur in the signal cable shield.

Signals from controller to amplifier are referenced to controller ground, and other power supplies in user equipment. These power supplies should also connect to system ground and earth at some point so that they are at same potential as the amplifier circuits.

The final configuration should have three current-carrying loops. First, the power supply currents flowing into and out of the amplifier at the +HV and Gnd pins on J1. Second the amplifier outputs driving currents into and out of the motor, and motor shield currents circulating between the (+) and (-) outputs and Gnd. And, lastly, logic and signal currents connected to the amplifier control inputs and outputs.

For CE compliance and operator safety, the amplifier should be earthed by using external tooth lockwashers under the mounting screws. These will make contact with the aluminum chassis through the anodized finish to connect the chassis to the equipment frame ground.

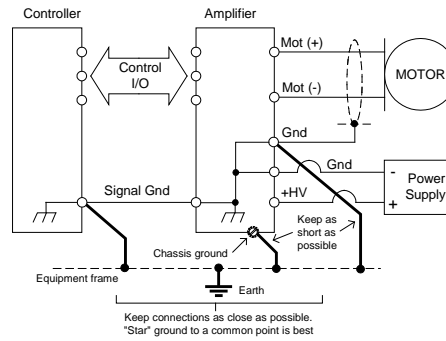

POWER SUPPLIES

Junus™ operates typically from transformer-isolated, unregulated DC power supplies. These should be sized such that the maximum output voltage under high-line and no-load conditions does not exceed the amplifiers maximum voltage rating. Power supply rating depends on the power delivered to the load by the amplifier. In many cases, the continuous power output of the amplifier is considerably higher than the actual power required by an incremental motion application.

Operation from regulated switching power supplies is possible if a diode is placed between the power supply and amplifier to prevent regenerative energy from reaching the output of the supply. If this is done, there must be external capacitance between the diode and amplifier.

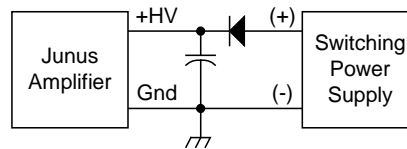

MOUNTING & COOLING

Junus™ has slots for mounting to panels at 0° or 90°. Cooling is by conduction from amplifier heatplate to mounting surface, or by convection to ambient.

FUSING & PROTECTIONS

Fusing of input power connections to Junus™ protects external circuits from an uncontrolled failure of the amplifier. Fusing of motor phase connections provides protection of the motor from overcurrents due to either mis-configuration of the amplifier, or uncontrolled failure of the amplifier. Motor phase fusing is recommended for motor applications that have lower thermal capacities. In many applications, Junus™ will have peak and continuous ratings greater than the motors' ratings, so operator errors during setup or adjustments can easily damage the motor with little stress to the amplifier.

Depending on the application dual fuses may be a choice for motor protection. Typically, one fuse provides sufficient protection for motor, but if grounding of the motor winding is possible, then two fuses would provide complete protection for any overcurrents flowing out of the amplifier and into the motor.

Sizing of motor fuses should take into account the peak and rms current over the anticipated duty cycle of the motor, and motor ratings. The final value selected should be tested in the equipment to prove that no false tripping occurs under worst-case temperature and operating-current conditions.

The maximum input current to the amplifier should not exceed its rated output currents under normal operating conditions. Time-delay fuses typically carry 75% of their rating continuously, so choosing a fuse that can carry 33% more current than the continuous current rating of the amplifier should be prevent false tripping. The DC voltage rating should be sufficient to carry the amplifier +HV operating voltage.

AMPLIFIER CONNECTIONS

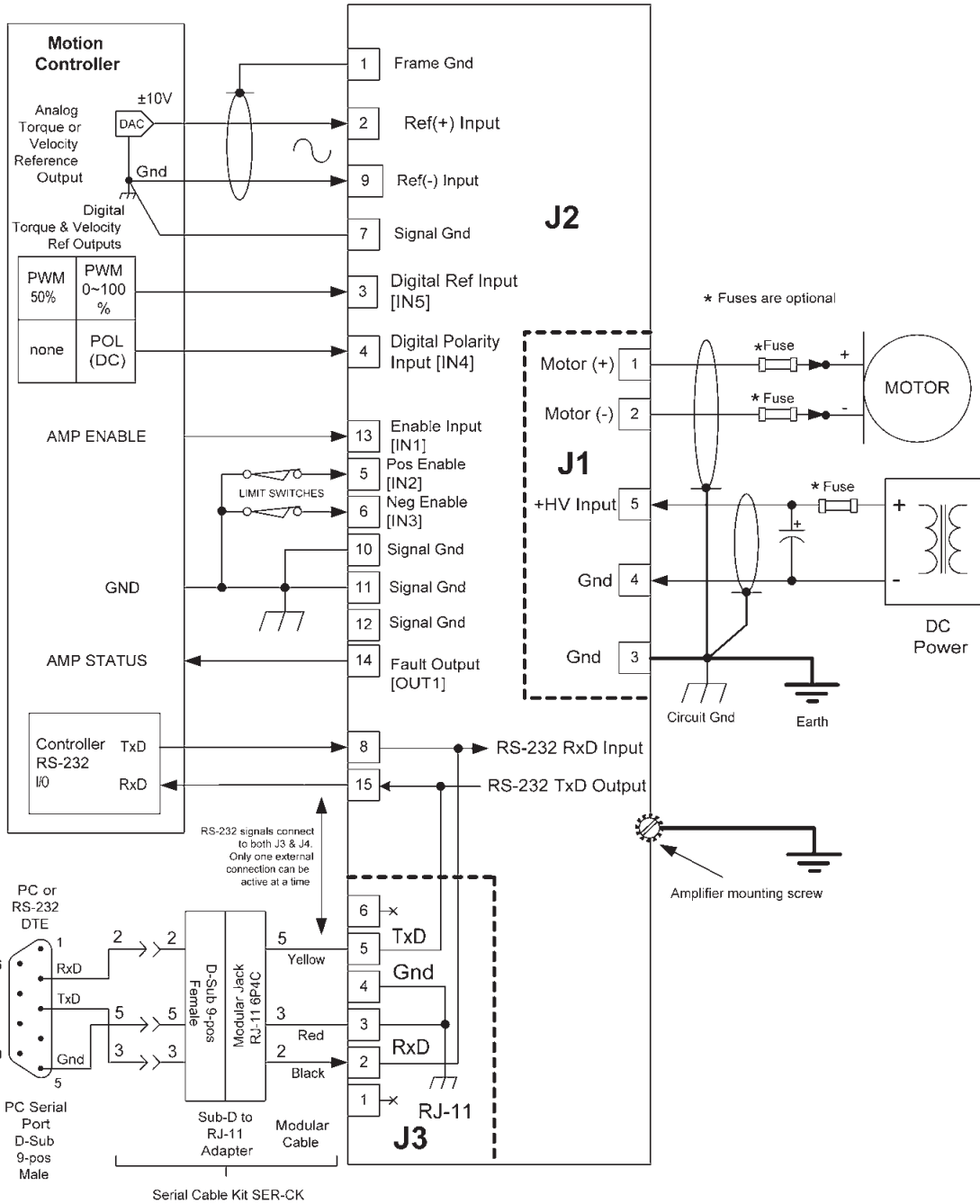

NOTES

- Input resistors for [IN1], [IN2], and [IN3] connect to a common bus that is programmable to be +5 Vdc or ground to give a pull-up or pull-down function. The function and active level of the following signals are programmable. Default functions are shown below.

J2-5	[IN2]	Pos Enable Input
J2-6	[IN3]	Neg Enable Input
J2-14	[OUT1]	Fault Output
- The function of [IN1] is always Amplifier Enable and is not programmable. The active level of [IN1] is programmable, and amplifier Reset with enable is programmable.

AMPLIFIER CONNECTORS

- J1: +HV, Gnd, & Motor Outputs**
Molex/Beau 5,08mm, Eurostyle®, 5-position receptacle
- J2: Signal:**
Sub-D, 15-position, female, #4-40 standoffs for cable-connector shell screws
- J3: RS-232:**
Modular connector, RJ-11 style 6-position, 4-contact

MATING (CABLE) CONNECTORS

- P1:** Molex/Beau 5,08mm, Eurostyle®, 5-position terminal block 860505-00, or equivalent
- P2:** Sub-D, 15-position, male, #4-40 locking screws
- P3:** Modular plug, RJ-11 style, 6-position, 4-contact
- Note: Junus™ Connector Kit JSP-CK contains one each of the P1 & P2 connectors. P3 is part of cable assembly in Serial Cable Kit SER-CK

J3 SIGNAL	PIN
No Connection	6
TxD Output	5
Signal Ground	4
Signal Ground	3
RxD Input	2
No Connection	1

J2 SIGNAL	PIN
Chassis Ground	1
Ref(+) Input	2
PWM Input [IN5]	3
Direction Input [IN4]	4
Pos Enable [IN2]	5
Neg Enable [IN3]	6
Signal Ground	7
RS-232 RxD	8

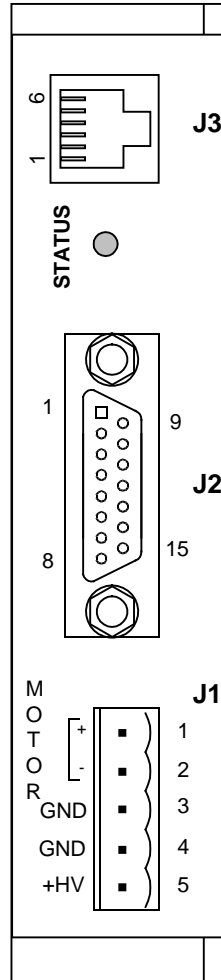

Pin	J2 SIGNAL
9	Ref(-) Input
10	Signal Ground
11	Signal Ground
12	Signal Ground
13	[IN1] Enable Input
14	[OUT1] Fault Output
15	RS-232 TxD

PIN	J1 SIGNAL
1	Motor (+) Output
2	Motor (-) Output
3	Ground
4	Ground
5	+HV Input

POWER DISSIPATION

The charts on this page show the amplifier internal power dissipation for all Junus™ models under differing power supply and output current conditions. Amplifier output current is calculated from the motion profile, motor, and load conditions. The values on the chart represent the rms (root-mean-square) current that the amplifier would provide during operation. The +HV values are for the average DC voltage of the amplifier power supply.

When +HV and amplifier output current are known, the amplifier power dissipation can be found from the chart. Once this is done use the data on the facing page to find amplifier thermal resistance. From this calculate the maximum ambient operating temperature. If this result is lower than the known maximum ambient temperature then a mounting with a lower thermal resistance must be used.

When the amplifier is disabled the power dissipation is shown on the chart as "Off". Note that this is a different value than that of an amplifier that is "On" but outputting 0 A current.

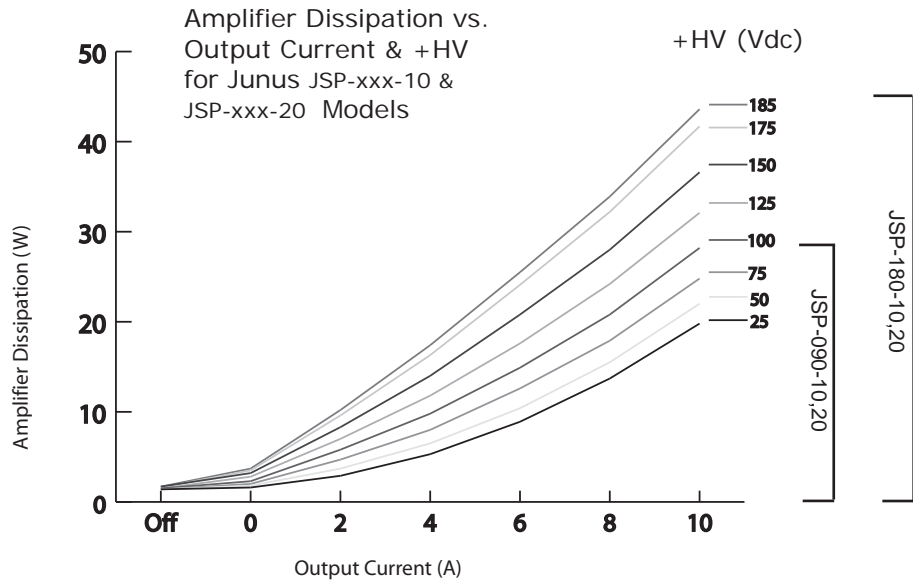

$\Delta T = P_{diss} * R_{th}$
MaxAmb = 70 - ΔT

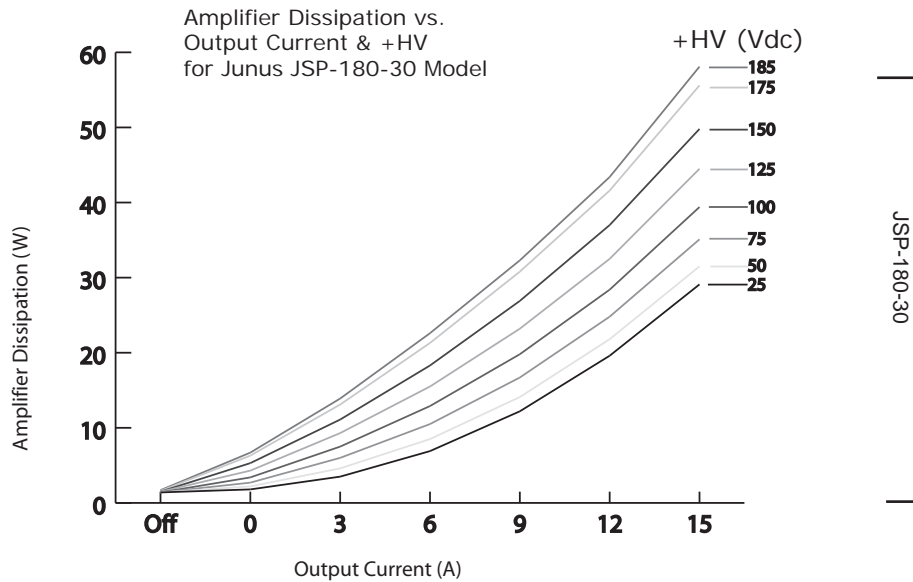

ΔT = Temperature rise above ambient (°C)
P_{diss} = Amplifier power dissipation (W)
R_{th} = thermal resistance (°C/W)
MaxAmb = Maximum ambient temperature for operating amplifier (°C)

MOUNTING

Thermal data for convection-cooling with a heatsink assumes a vertical mounting of the amplifier on a thermally conducting surface. Heatsink fins run parallel to the long axis of the amplifier. When fan-cooling is used vertical mounting is not necessary to guarantee thermal performance of the heatsink.

THERMAL RESISTANCE

Thermal resistance is a measure of the temperature rise of the amplifier heatplate due to power dissipation in the amplifier. It is expressed in units of °C/W where the degrees are the temperature rise above ambient.

E.g., an amplifier dissipating 20 W mounted with no heatsink or fan would see a temperature rise of 28 °C above ambient based on the thermal resistance of 1.4 °C/W. Using the amplifier maximum heatplate temperature of 70 °C and subtracting 28 °C from that would give 42 °C as the maximum ambient temperature the amplifier in which the amplifier could operate before going into thermal shutdown.

TOP VIEW, VERTICAL MOUNTING

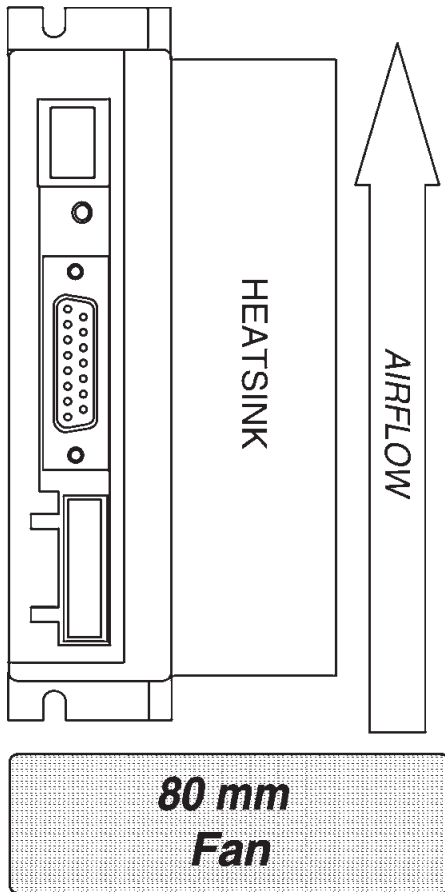

**END VIEWS
VERTICAL MOUNTING**

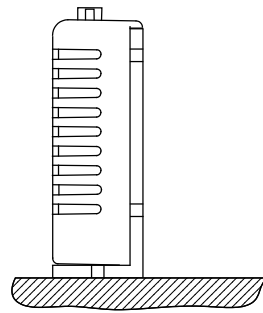

NO HEATSINK, NO FAN	°C/W
CONVECTION	1.4

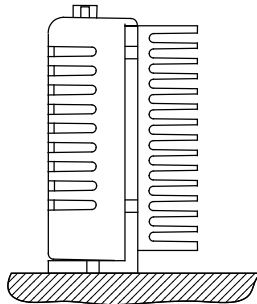

HEATSINK, NO FAN	°C/W
CONVECTION	0.8

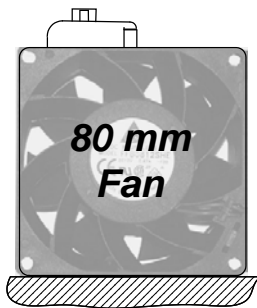

HEATSINK + FAN	°C/W
FORCE-AIR, 300 LFM	0.6

DIMENSIONS

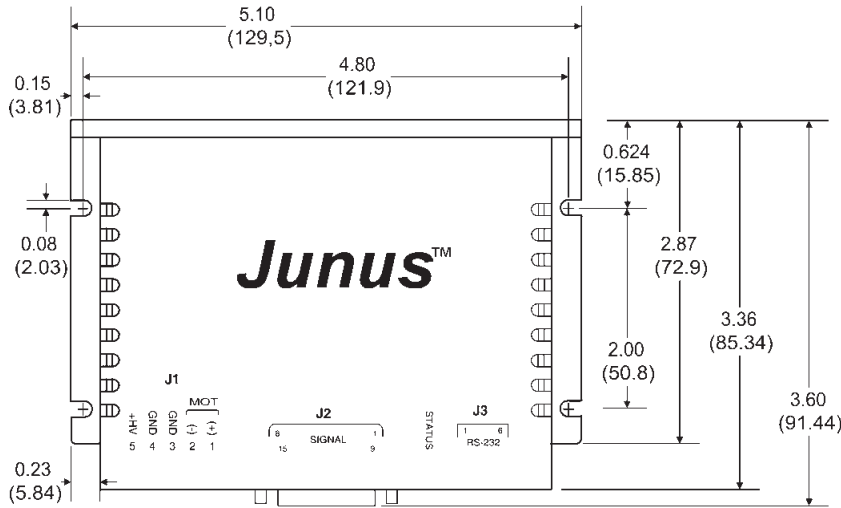

NOTES

1. Dimensions shown in inches (mm).
2. Use external tooth lockwashers between mounting screw head and amplifier chassis for safety and CE compliance. Recommended screws are #6-32 (M3.5) torqued to 8~10 lb-in (0.79~1.02 N·m).

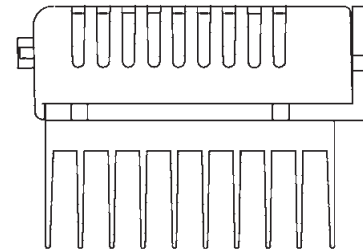
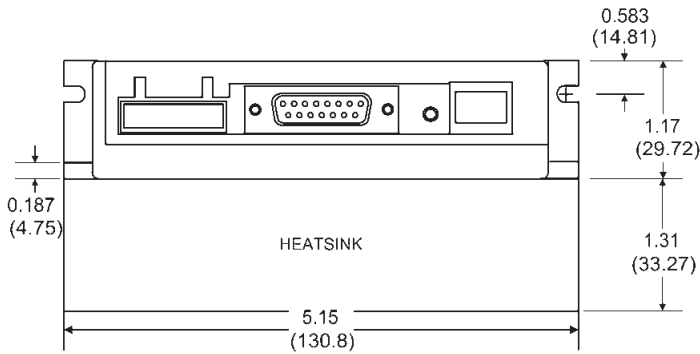

ORDERING GUIDE

PART NUMBER	DESCRIPTION
JSP-090-10	Junus Servoamplifier 5/10 Adc @ 90 Vdc
JSP-090-20	Junus Servoamplifier 10/20 Adc @ 90 Vdc
JSP-180-10	Junus Servoamplifier 5/10 Adc @ 180 Vdc
JSP-180-20	Junus Servoamplifier 10/20 Adc @ 180 Vdc
JSP-180-30	Junus Servoamplifier 15/30 Adc @ 180 Vdc
JSP-CK	Connector Kit
SER-CK	Serial Cable Kit
CME2	CME2 CD-ROM (Contains CME2 & manual)
-H	Heatsink fitted to amplifier at factory
JSP-HK	Heatsink kit for field-fitting to amplifier

ORDERING INSTRUCTIONS

Example: Order 1 JSP-090-20 amplifier with associated components and factory installed heatsink:

Qty	Item	Remarks
1	JSP-090-20-H	Junus™ amplifier + heatsink
1	JSP-CK	Connector Kit
1	SER-CK	Serial Cable Kit
1	CME2	CME 2™ CD

Note: The heatsink can be fitted at the factory by adding a "-H" to the amplifier part number. For fitting a heatsink to an t amplifier in the field, a complete kit is available as a separate part "JSP-HK". The kit contains a heatsink, mounting hardware, and phase-change material.

ROHS COMPLIANCE



Models with the green leaf symbol on the label are RoHS compliant.